

AM RECEIVER CIRCUIT

GENERAL DESCRIPTION

The TDA1072A integrated AM receiver circuit performs the active and part of the filtering functions of an AM radio receiver. It is intended for use in mains-fed home receivers and car radios. The circuit can be used for oscillator frequencies up to 50 MHz and can handle r.f. signals up to 500 mV. R.F. radiation and sensitivity to interference are minimized by an almost symmetrical design. The voltage-controlled oscillator provides signals with extremely low distortion and high spectral purity over the whole frequency range even when tuning with variable capacitance diodes. If required, band switching diodes can easily be applied. Selectivity is obtained using a block filter before the i.f. amplifier.

Features

- Inputs protected against damage by static discharge
- Gain-controlled r.f. stage
- Double balanced mixer
- Separately buffered, voltage-controlled and temperature-compensated oscillator, designed for simple coils
- Gain-controlled i.f. stage with wide a.g.c. range
- Full-wave, balanced envelope detector
- Internal generation of a.g.c. voltage with possibility of second-order filtering
- Buffered field strength indicator driver with short-circuit protection
- A.F. preamplifier with possibilities for simple a.f. filtering
- Electronic standby switch

QUICK REFERENCE DATA

Supply voltage range	V_P	7,5 to 18 V
Supply current range	I_P	15 to 30 mA
R.F. input voltage for $S + N/N = 6$ dB at $m = 30\%$	V_i	typ. 1,5 μ V
R.F. input voltage for 3% total harmonic distortion (THD) at $m = 80\%$	V_i	typ. 500 mV
A.F. output voltage with $V_i = 2$ mV; $f_i = 1$ MHz; $m = 30\%$ and $f_m = 400$ Hz	$V_{O(af)}$	typ. 310 mV
A.G.C. range: change of V_i for 1 dB change of $V_{O(af)}$		typ. 86 dB
Field strength indicator voltage at $V_i = 500$ mV; $R_{L(g)} = 2,7$ k Ω	V_{IND}	typ. 2,8 V

PACKAGE OUTLINE

16-lead DIL; plastic (SOT38).

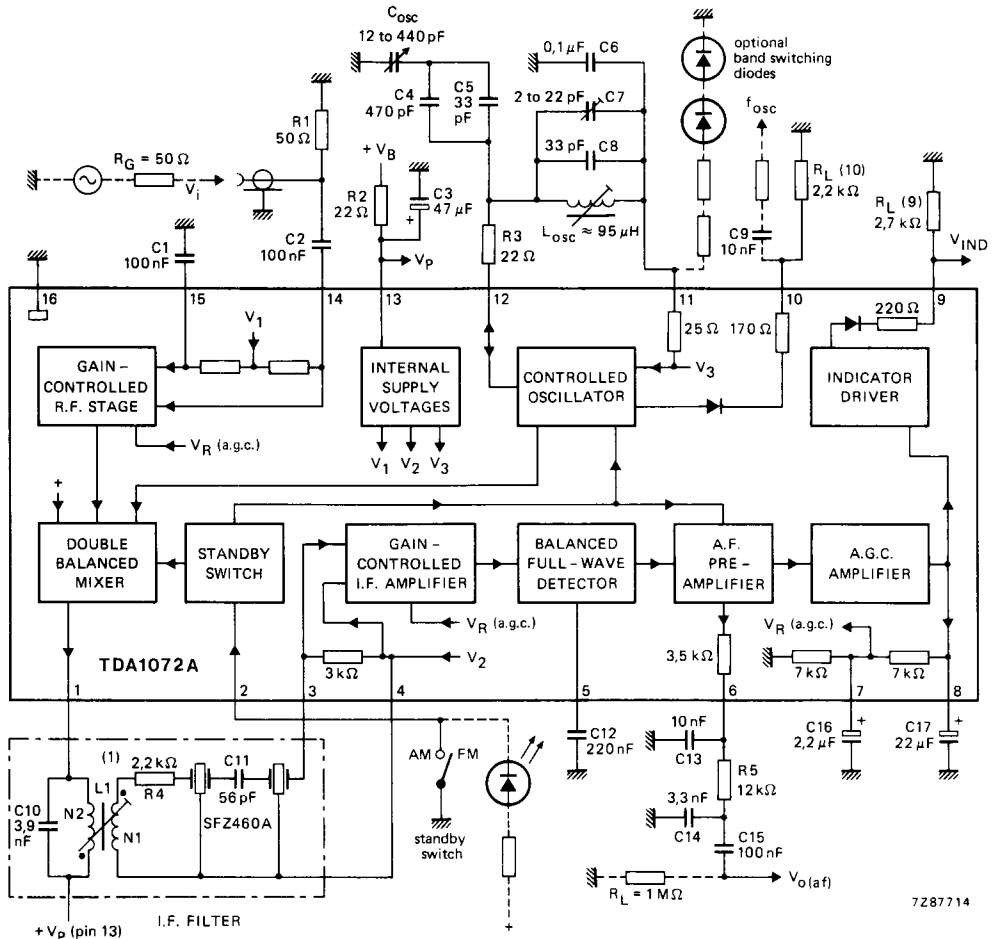

(1) Coil data: TOKO sample no. 7XNS-A7523DY; $L1 : N1/N2 = 12/32$; $Q_o = 65$; $Q_B = 57$.
 Filter data: $Z_F = 700 \Omega$ at $R_{3,4} = 3 \text{ k}\Omega$; $Z_I = 4,8 \text{ k}\Omega$.

Fig. 1 Block diagram and test circuit (connections shown in broken lines are not part of the test circuit).

FUNCTIONAL DESCRIPTION

Gain-controlled r.f. stage and mixer

The differential amplifier in the r.f. stage employs an a.g.c. negative feedback network to provide a wide dynamic range. Very good cross-modulation behaviour is achieved by a.g.c. delays at the various signal stages. Large signals are handled with low distortion and the S/N ratio of small signals is improved. Low noise working is achieved in the differential amplifier by using transistors with low base resistance. A double balanced mixer provides the i.f. output signal to pin 1.

Oscillator

The differential amplifier oscillator is temperature compensated and is suitable for simple coil connection. The oscillator is voltage-controlled and has little distortion or spurious radiation. It is specially suitable for electronic tuning using variable capacitance diodes. Band switching diodes can easily be applied using the stabilized voltage V_{11-16} . An extra buffered oscillator output (pin 10) is available for driving a synthesizer. If this is not needed, resistor $R_{L(10)}$ can be omitted.

Gain-controlled i.f. amplifier

This amplifier comprises two cascaded, variable-gain differential amplifier stages coupled by a band-pass filter. Both stages are gain-controlled by the a.g.c. negative feedback network.

Detector

The full-wave, balanced envelope detector has very low distortion over a wide dynamic range. Residual i.f. carrier is blocked from the signal path by an internal low-pass filter.

A.F. preamplifier

This stage preamplifies the audio frequency output signal. The amplifier output has an emitter follower with a series resistor which, together with an external capacitor, yields the required low-pass for a.f. filtering.

A.G.C. amplifier

The a.g.c. amplifier provides a control voltage which is proportional to the carrier amplitude. Second-order filtering of the a.g.c. voltage achieves signals with very little distortion, even at low audio frequencies. This method of filtering also gives fast a.g.c. settling time which is advantageous for electronic search tuning. The a.g.c. settling time can be further reduced by using capacitors of smaller value in the external filter (C16 and C17). The a.g.c. voltage is fed to the r.f. and i.f. stages via suitable a.g.c. delays. The capacitor at pin 7 can be omitted for low-cost applications.

Field strength indicator output

A buffered voltage source provides a high-level field strength output signal which has good linearity for logarithmic input signals over the whole dynamic range. If the field strength information is not needed, $R_{L(9)}$ can be omitted.

Standby switch

This switch is primarily intended for AM/FM band switching. During standby mode the oscillator, mixer and a.f. preamplifier are switched off.

Short-circuit protection

All pins have short-circuit protection to ground.

RATINGS

Limiting values in accordance with the Absolute Maximum Rating System (IEC 134)

Supply voltage	$V_P = V_{13-16}$	max.	20 V
Total power dissipation	P_{tot}	max.	875 mW
Input voltage	$ V_{14-15} $	max.	12 V
	$-V_{14-16}, -V_{15-16}$	max.	0,6 V
	V_{14-16}, V_{15-16}	max.	V_P V
Input current	$ I_{14} , I_{15} $	max.	200 mA
Operating ambient temperature range	T_{amb}	-40 to +80	°C
Storage temperature range	T_{stg}	-55 to +150	°C
Junction temperature	T_j	max.	+125 °C

THERMAL RESISTANCE

From junction to ambient	$R_{th\ j-a}$	=	80 K/W
--------------------------	---------------	---	--------

DEVICE CHARACTERISTICS

$V_P = V_{13-16} = 8,5$ V; $T_{amb} = 25$ °C; $f_i = 1$ MHz; $f_m = 400$ Hz; $m = 30\%$; $f_{if} = 460$ kHz; measured in test circuit of Fig. 1; unless otherwise specified

parameter	symbol	min.	typ.	max.	unit
Supplies					
Supply voltage	$V_P = V_{13-16}$	7,5	8,5	18	V
Supply current	$I_P = I_{13}$	15	23	30	mA
R.F. stage and mixer					
Input voltage (d.c. value)	V_{14-16}, V_{15-16}	—	$V_P/2$	—	V
R.F. input impedance at $V_i < 300$ μ V	R_{14-16}, R_{15-16}	—	5,5	—	k Ω
	C_{14-16}, C_{15-16}	—	25	—	pF
R.F. input impedance at $V_i > 10$ mV	R_{14-16}, R_{15-16}	—	8	—	k Ω
	C_{14-16}, C_{15-16}	—	22	—	pF
I.F. output impedance	R_{1-16}	500	—	—	k Ω
	C_{1-16}	—	6	—	pF
Conversion transconductance before start of a.g.c.	I_1/V_i	—	6,5	—	mA/V
Maximum i.f. output voltage, inductive coupling to pin 1	$V_{1-13(p-p)}$	—	5	—	V
D.C. value of output current (pin 1) at $V_i = 0$ V	I_1	—	1,2	—	mA
A.G.C. range of input stage		—	30	—	dB
R.F. signal handling capability: input voltage for THD = 3% at $m = 80\%$	$V_{i(rms)}$	—	500	—	mV

parameter	symbol	min.	typ.	max.	unit
Oscillator					
Frequency range	f_{osc}	0,6	—	60	MHz
Oscillator amplitude (pins 11 to 12)	V_{11-12}	—	130	150	mV
External load impedance	$R_{12-11(ext)}$	0,5	—	200	$k\Omega$
External load impedance for no oscillation	$R_{12-11(ext)}$	—	—	60	Ω
Ripple rejection at $V_{p(rms)} = 100$ mV; $f_p = 100$ Hz ($RR = 20 \log [V_{13-16}/V_{11-16}]$)	RR	—	55	—	dB
Source voltage for switching diodes ($6 \times V_{BE}$)	V_{11-16}	—	4,2	—	V
D.C. output current (for switching diodes)	$-I_{11}$	0	—	20	mA
Change of output voltage at $\Delta I_{11} = 20$ mA (switch to maximum load)	ΔV_{11-16}	—	0,5	—	V
Buffered oscillator output					
D.C. output voltage	V_{10-16}	—	0,7	—	V
Output signal amplitude	$V_{10-16(p-p)}$	—	320	—	mV
Output impedance	R_{10}	—	170	—	Ω
Output current	$-I_{10(peak)}$	—	—	3	mA
I.F., a.g.c. and a.f. stages					
D.C. input voltage	V_{3-16}, V_{4-16}	—	2,0	—	V
I.F. input impedance	R_{3-4} C_{3-4}	2,4	3	3,9	$k\Omega$ pF
I.F. input voltage for THD = 3% at $m = 80\%$	V_{3-4}	—	90	—	mV
Voltage gain before start of a.g.c.	V_{3-4}/V_{6-16}	—	68	—	dB
A.G.C. range of i.f. stages: change of V_{3-4} for 1 dB change of $V_{O(af)}$; $V_{3-4(ref)} = 75$ mV	ΔV_{3-4}	—	55	—	dB
A.F. output voltage at $V_{3-4(if)} = 50$ μ V	$V_{O(af)}$	—	130	—	mV
A.F. output voltage at $V_{3-4(if)} = 1$ mV	$V_{O(af)}$	—	310	—	mV
A.F. output impedance (pin 6)	$ Z_o $	—	3,5	—	$k\Omega$
Indicator driver					
Output voltage at $V_i = 0$ mV; $R_{L(9)} = 2,7$ $k\Omega$	V_{9-16}	—	20	150	mV
Output voltage at $V_i = 500$ mV; $R_{L(9)} = 2,7$ $k\Omega$	V_{9-16}	2,5	2,8	3,1	V
Load resistance	$R_{L(9)}$	1,5	—	—	$k\Omega$

DEVICE CHARACTERISTICS (continued)

parameter	symbol	min.	typ.	max.	unit
Standby switch					
Switching threshold at $V_P = 7,5$ to 18 V; $T_{amb} = -40$ to $+80$ °C					
on-voltage	V_{2-16}	0	—	2,0	V
off-voltage	V_{2-16}	3,5	—	20	V
on-current at $V_{2-16} = 0$ V	$-I_2$	—	—	200	μ A
off-current at $V_{2-16} = 20$ V	$ I_2 $	—	—	10	μ A

OPERATING CHARACTERISTICS

$V_P = 8,5$ V; $f_i = 1$ MHz; $m = 30\%$; $f_m = 400$ Hz; $T_{amb} = 25$ °C; measured in Fig. 1; unless otherwise specified

parameter	symbol	min.	typ.	max.	unit
R.F. sensitivity					
R.F. input required for $S + N/N = 6$ dB	V_i	—	1,5	—	μ V
R.F. input required for $S + N/N = 26$ dB	V_i	—	15	—	μ V
R.F. input required for $S + N/N = 46$ dB	V_i	—	150	—	μ V
R.F. input at start of a.g.c.	V_i	—	30	—	μ V
R.F. large signal handling					
R.F. input at THD = 3%; $m = 80\%$	V_i	—	500	—	mV
R.F. input at THD = 3%; $m = 30\%$	V_i	—	700	—	mV
R.F. input at THD = 10%; $m = 30\%$	V_i	—	900	—	mV
A.G.C. range					
Change of V_i for 1 dB change of $V_{O(af)}$; $V_{i(ref)} = 500$ mV	ΔV_i	—	86	—	dB
Change of V_i for 6 dB change of $V_{O(af)}$; $V_{i(ref)} = 500$ mV	ΔV_i	—	91	—	dB
Output signal					
A.F. output voltage at $V_i = 4$ μ V; $m = 80\%$	$V_{O(af)}$	—	130	—	mV
A.F. output voltage at $V_i = 1$ mV	$V_{O(af)}$	240	310	390	mV
THD at $V_i = 1$ mV; $m = 80\%$	d_{tot}	—	0,5	—	%
THD at $V_i = 500$ mV; $m = 30\%$	d_{tot}	—	1	—	%
Signal-to-noise ratio at $V_i = 100$ mV	$(S + N)/N$	—	58	—	dB
Ripple rejection at $V_i = 2$ mV; $V_{P(rms)} = 100$ mV; $f_P = 100$ Hz ($RR = 20 \log [V_P/V_{O(af)}]$)	RR	—	38	—	dB

parameter	symbol	min.	typ.	max.	unit
Unwanted signals					
Suppression of i.f. whistles at $V_i = 15 \mu V$; $m = 0\%$ related to a.f. signal of $m = 30\%$					
at $f_i \approx 2 \times f_{if}$	α_{2if}	—	37	—	dB
at $f_i \approx 3 \times f_{if}$	α_{3if}	—	44	—	dB
I.F. suppression at r.f. input					
for symmetrical input	α_{if}	—	40	—	dB
for asymmetrical input	α_{if}	—	40	—	dB
Residual oscillator signal at mixer output					
at f_{osc}	$I_1(osc)$	—	1	—	μA
at $2 \times f_{osc}$	$I_1(2osc)$	—	1,1	—	μA

APPLICATION INFORMATION

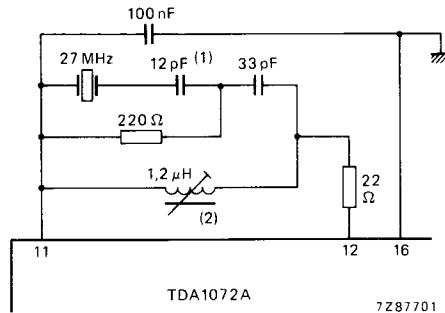

- (1) Capacitor values depend on crystal type.
- (2) Coil data: 9 windings of 0,1 mm dia laminated Cu wire on TOKO coil set 7K 199CN; $Q_0 = 80$.

Fig. 2 Oscillator circuit using quartz crystal; centre frequency = 27 MHz.

APPLICATION INFORMATION (continued)

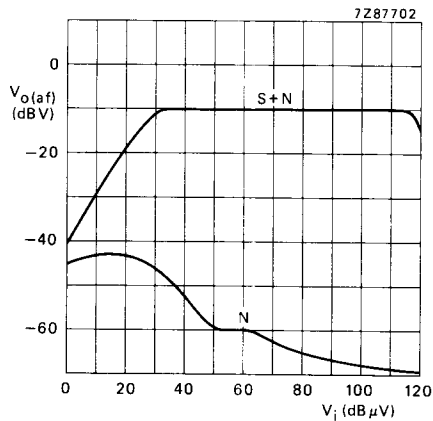

Fig. 3 A.F. output as a function of r.f. input in the circuit of Fig. 1; $f_i = 1 \text{ MHz}$; $f_m = 400 \text{ Hz}$; $m = 30\%$.

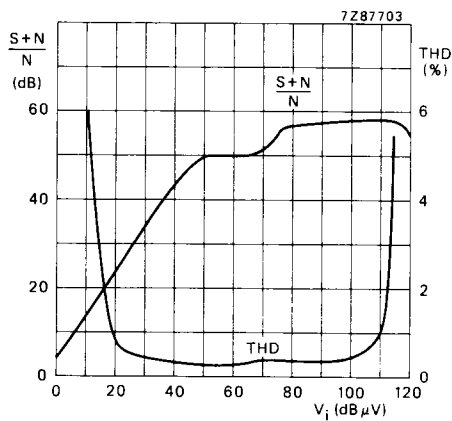

Fig. 4 Total harmonic distortion and $(S + N)/N$ as functions of r.f. input in the circuit of Fig. 1; $m = 30\%$ for $(S + N)/N$ curve and $m = 80\%$ for THD curve.

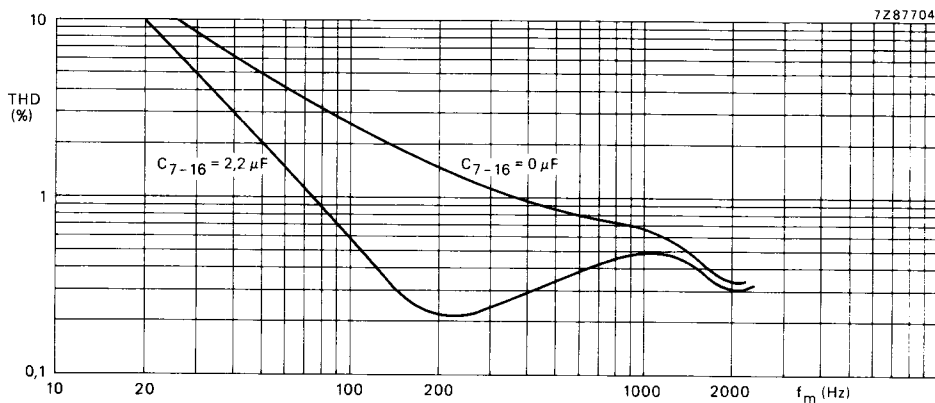

Fig. 5 Total harmonic distortion as a function of modulation frequency at $V_i = 5 \text{ mV}$; $m = 80\%$; measured in the circuit of Fig. 1 with $C_{7-16(\text{ext})} = 0 \mu\text{F}$ and $2,2 \mu\text{F}$.

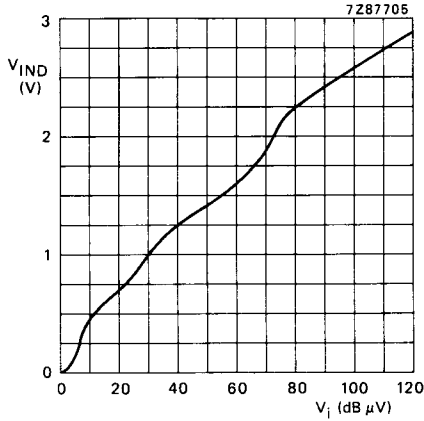

Fig. 6 Indicator driver voltage as a function of r.f. input in the circuit of Fig. 1.

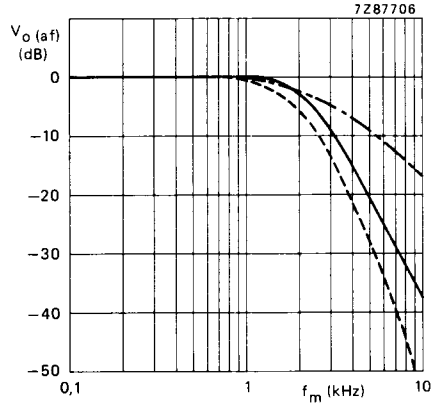

Fig. 7 Typical frequency response curves from Fig. 1 showing the effect of filtering as follows:

- with i.f. filter;
- - - with a.f. filter;
- · - · with i.f. and a.f. filters.

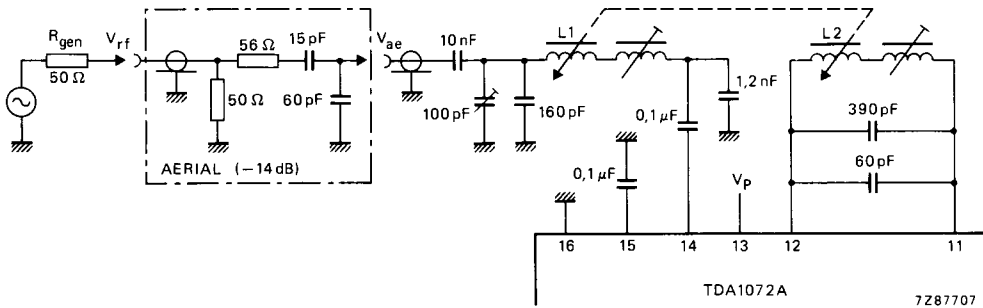

Fig. 8 Car radio application with inductive tuning.

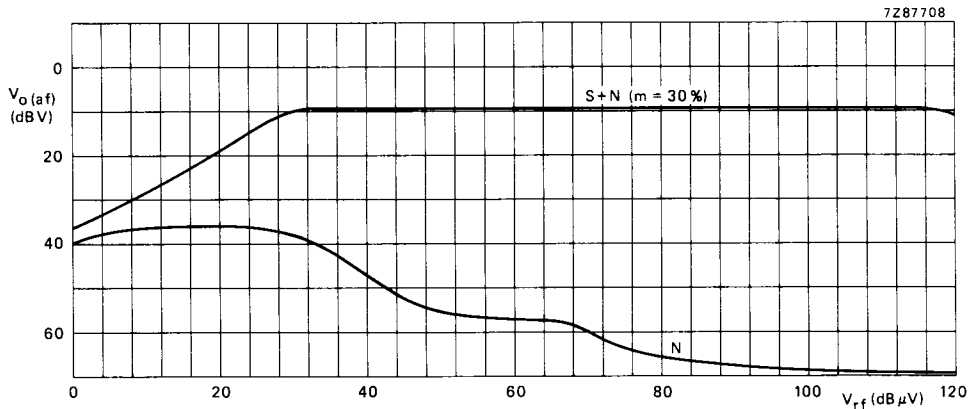

Fig. 9 A.F. output as a function of r.f. input using the circuit of Fig. 8 with that of Fig. 1.

APPLICATION INFORMATION (continued)

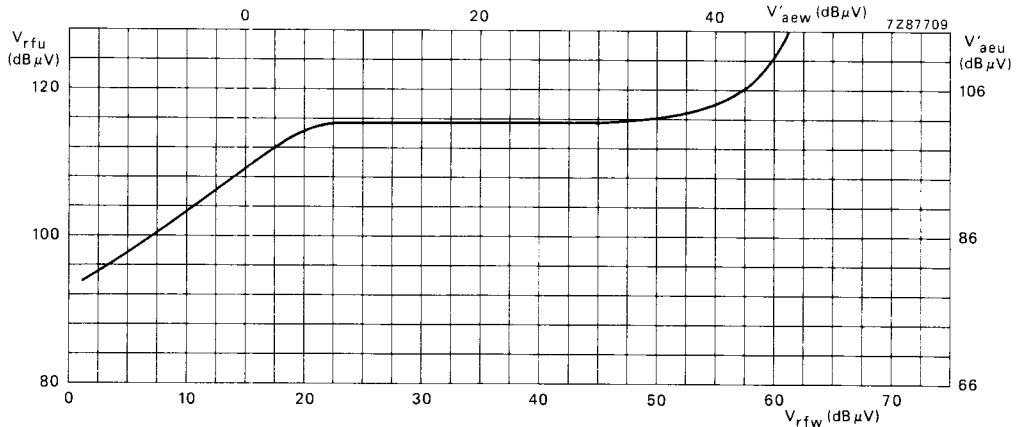

Fig. 10 Suppression of cross-modulation as a function of input signal, measured in the circuit of Fig. 8 with the input circuit as shown in Fig. 11. Curve is for Wanted $V_{O(af)}/$ Unwanted $V_{O(af)} = 20$ dB; V_{rfw} , V_{rfu} are signals at the aerial input, V'_{aew} , V'_{aeu} are signals at the unloaded output of the aerial. Wanted signal (V'_{aew} , V_{rfw}): $f_i = 1$ MHz; $f_m = 400$ Hz; $m = 30\%$. Unwanted signal (V'_{aeu} , V_{rfu}): $f_i = 900$ kHz; $f_m = 400$ Hz; $m = 30\%$. Effective selectivity of input tuned circuit = 21 dB.

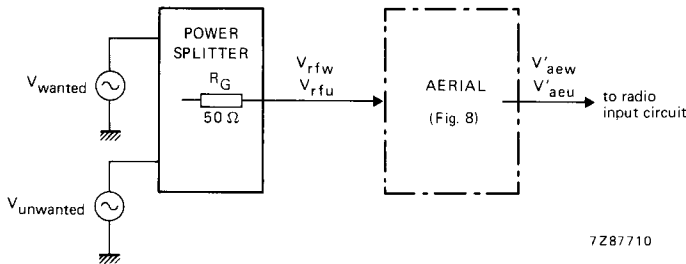

Fig. 11 Input circuit to show cross-modulation suppression (see Fig. 10).

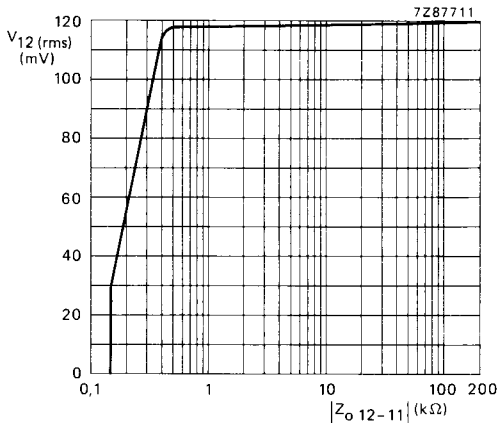

Fig. 12 Oscillator amplitude as a function of pin 11, 12 impedance in the circuit of Fig. 8.

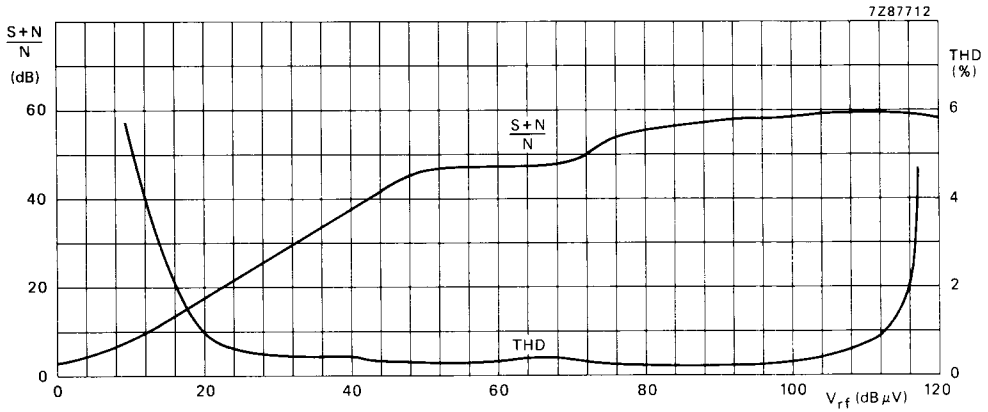

Fig. 13 Total harmonic distortion and (S + N)/N as functions of r.f. input using the circuit of Fig. 8 with that of Fig. 1.

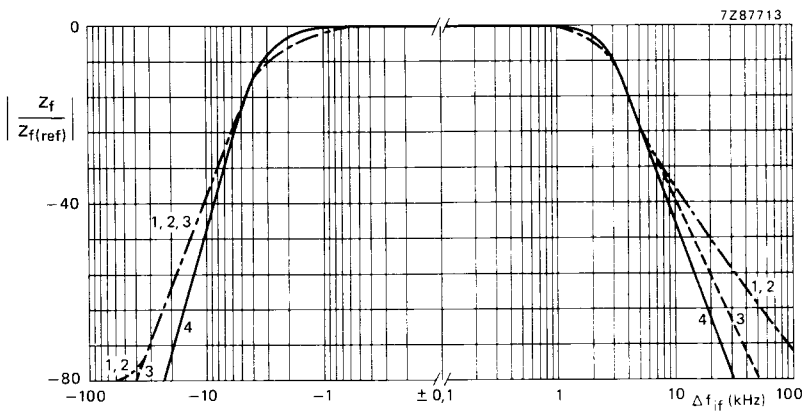
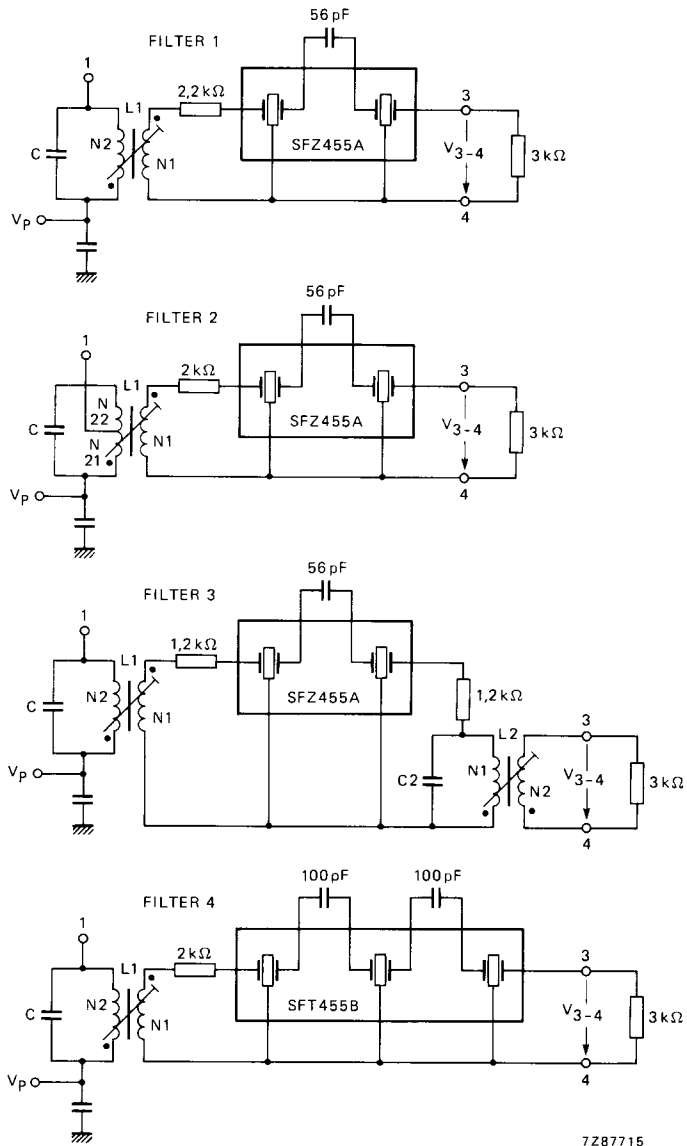

Fig. 14 Forward transfer impedance as a function of intermediate frequency for filters 1 to 4 shown in Fig. 15; centre frequency = 455 kHz.





APPLICATION INFORMATION (continued)



7Z87715

Fig. 15 I.F. filter variants applied to the circuit of Fig. 1. For filter data, refer to Table 1.

Table 1 Data for I.F. filters shown in Fig. 15. Criterion for adjustment is Z_F = maximum (optimum selectivity curve at centre frequency $f_0 = 455$ kHz). See also Fig. 14.

filter no.	1	2	3		4	unit
Coil data	L1	L1	L1	L2	L1	
Value of C	3900	430	3900	4700	3900	pF
N1 : N2	12 : 32	13 : (33 + 66)	15 : 31	29 : 29	13 : 31	
Diameter of Cu laminated wire	0,09	0,08	0,09	0,08	0,09	mm
O_0	65 (typ.)	50	75	60	75	
Schematic* of windings						
Toko order no.	7XNS-A7523DY	L7PES-A0060BTG	7XNS-A7518DY	7XNS-A7521AIH	7XNS-A7519DY	
Resonators						
Murata type	SFZ455A	SFZ455A	SFZ455A	SFZ455A	SFT455B	
D (typical value)	4	4	4	4	6	dB
R _G , R _L	3	3	3	3	3	kΩ
Bandwidth (-3 dB)	4,2	4,2	4,2	4,2	4,5	kHz
S ₉ kHz	24	24	24	24	38	dB
Filter data						
Z ₁	4,8	3,8	52 (L1)	4,2	4,8	kΩ
r _{OB}	57	40		18 (L2)	55	kΩ
Z _F	0,70	0,67	0,68	0,68	0,68	kΩ
Bandwidth (-3 dB)	3,6	3,8	3,6	3,6	4,0	kHz
S ₉ kHz	35	31	36	36	42	dB
S ₁₈ kHz	52	49	54	54	64	dB
S ₂₇ kHz	63	58	66	66	74	dB

* The beginning of an arrow indicates the beginning of a winding. N1 is always the inner winding, N2 the outer winding.

APPLICATION INFORMATION (continued)

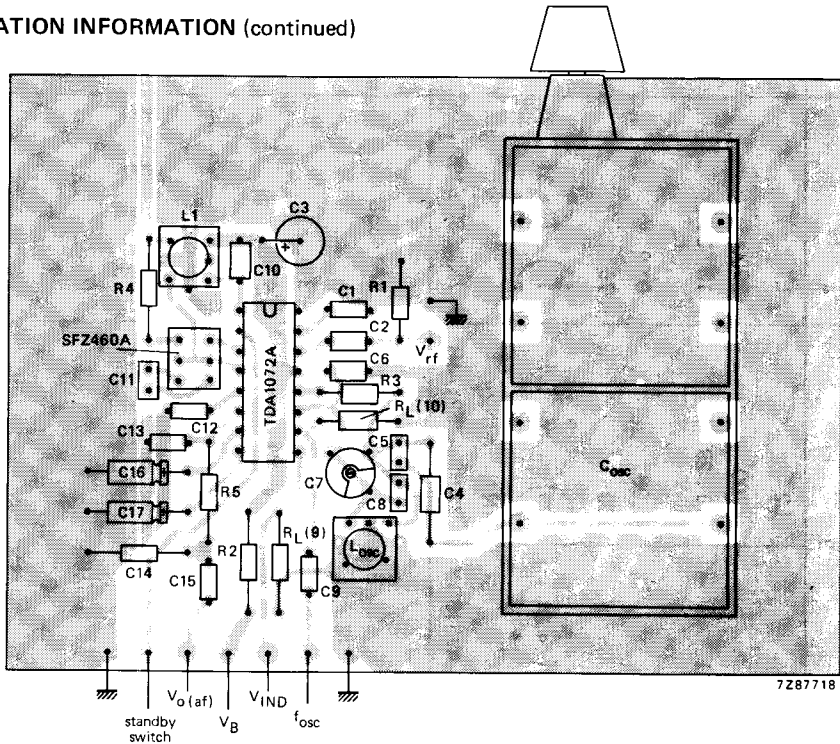

Fig. 16 Printed-circuit board component side, showing component layout. For circuit diagram see Fig. 1.

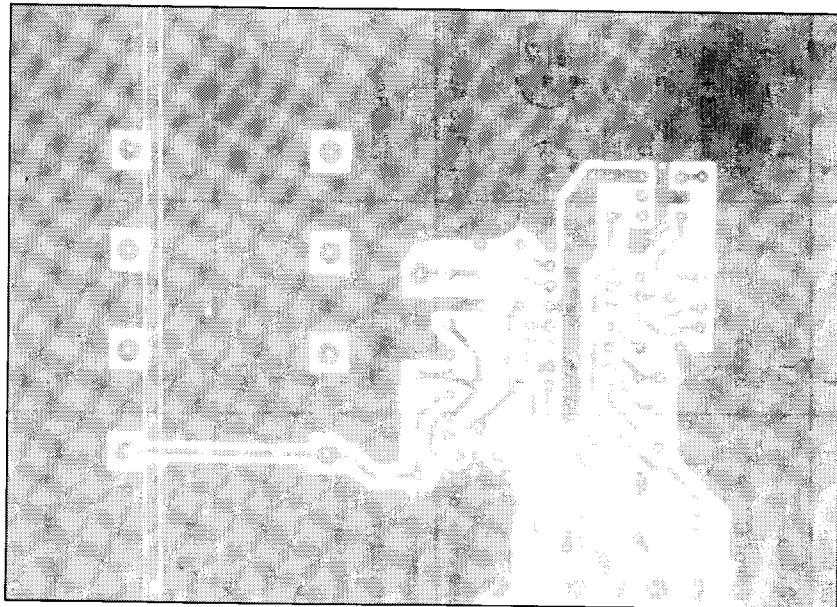

Fig. 17 Printed-circuit board showing track side.

